

## Alfa Romeo 159 Sportwagon 04/2006- Alfa Romeo 159 09/2005-

Partnr.: AF-012-BB

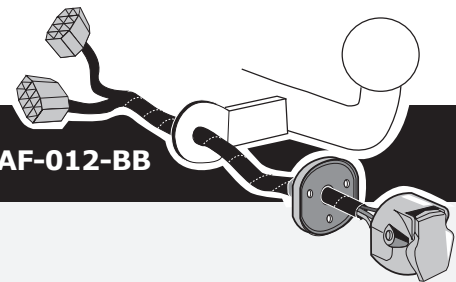

<b>DE</b>	<b>Einbauanleitung Elektrosatz Anhängervorrichtung mit 12-N Steckdose It. DIN/ISO Norm 1724.</b>	<b>CZ</b>	<b>Montážní pokyny: souprava pro elektrické propojení tažné tyče s 12 - N zásuvkou do normy DIN/ISO 1724.</b>
<b>FR</b>	<b>Instructions de montage du faisceau électrique pour crochet d'attelage conforme à la norme DIN/ISO 1724 prise 12-N</b>	<b>DK</b>	<b>Monteringsvejledninger for det elektriske ledningsføringssæt for trækstang med 12-N stikdåse, DIN/ISO, norm 1724.</b>
<b>NL</b>	<b>Montage-handleiding elektrokabelset voor trekhaak met 12-N contactdoos vlg. DIN/ISO norm 1724.</b>	<b>FI</b>	<b>Ohjeet vetokoukun sähkökaapelisarjan asentamiseen, jossa on DIN/ISO 1724 mukainen 12-N liitin.</b>
<b>GB</b>	<b>Fitting instructions electric wiring kit tow bar with 12-N socket up to DIN/ISO Norm 1724.</b>	<b>GR</b>	<b>Οδηγίες συναρμολόγησης ηλεκτρικού σετ καλωδίων μπάρας ρυμούλκησης με υποδοχή 12-N μέχρι DIN/ISO Κανόνας 1724.</b>
<b>ES</b>	<b>Instrucciones de montaje de kit eléctrico para enganche de remolque con caja de conexiones 12-N según norma DIN/ISO 1724.</b>	<b>NO</b>	<b>Monteringsanviser elkabelsett for trekrok med 12-N koblingsboks ifølge DIN/ISO norm 1724.</b>
<b>IT</b>	<b>Istruzioni di montaggio di set di cavi elettrici per gancio da traino con zoccolo a 12 N conforme alla norma DIN/ISO 1724.</b>	<b>PL</b>	<b>Instrukcje montażu zestawu okablowania elektrycznego dyszla holowniczego z 12-N stykowym gniazdem DIN/ISO 1724.</b>
<b>SE</b>	<b>Monteringsanvisningar elkabelsats för dragkrok med 12-N kontaktdosa enligt DIN/ISO norm 1724.</b>		

<b>DE</b>	- Wir weisen ausdrücklich darauf hin, dass eine unsachgemäße und nicht in einer Fachwerkstatt durchgeführte Montage einen Verzicht auf Entschädigung jeglicher Art insbesondere bezüglich des Produkthaftpflichtrechts zur Folge hat	- Technische Änderungen vorbehalten. - Widerstand nur gemäß der Tabelle auf dem Anhänger verwenden.
<b>FR</b>	- Il est expressément prévu qu' on ne saurait se prévaloir d'un quelconque préjudice contractuel ou réhibitoire si le montage avait été fait en dépit des dites instructions ou dans un garage ne disposant pas des équipements adéquats.	- Sous réserve de modifications techniques. - Ne excédez pas la charge maximale, indiquée dans le tableau.
<b>NL</b>	- Wij wijzen er met nadruk op, dat ondeskundige en niet door een vakkundige werkplaats uitgevoerde montage tot gevolg heeft dat daardoor ieder recht op schadevergoeding, ook op wettelijke aansprakelijkheid inzake producten, vervalt.	- Technische wijzigingen voorbehouden. - Gebruik alleen belasting volgens aansluittabel op het getrokken voertuig.
<b>GB</b>	- We would expressly point out that assembly not carried out properly by a competent installer will result in cancellation of any right to damage compensation, in particular those arising by virtue of the product liability act.	- Contents of these kits and their fitting manuals are subject to alteration without notice, please ensure that these instructions are read and fully understood before commencing installation. - Do not overload circuits; the maximum loads per connection are detailed in this manual.
<b>ES</b>	- El montaje inapropiado y efectuado por personal no cualificado originará la pérdida de todo derecho a indemnización o la expiración de toda responsabilidad civil con respecto al producto.	- Nos reservamos el derecho a efectuar modificaciones técnicas. - Utilice sólo cargas de acuerdo a la tabla de conexión del vehículo remolcado.
<b>IT</b>	- Sottolineiamo espressamente che un montaggio inadeguato ed eseguito da un'officina non specializzata ha come conseguenza il decadere di qualsiasi diritto al risarcimento danni, nonché alla responsabilità legale relativa ai prodotti.	- Ci si riserva il diritto di apportare modifiche tecniche. - Utilizzare esclusivamente un carico conforme alla tabella degli allacci relativa al veicolo in questione.
<b>SE</b>	- Vi påpekar med eftertryck att all rätt till skadeersättning och all laglig ansvarighet förfaller om monteringen inte har utförts på rätt sätt och av en professionell verkstad.	- Tekniska ändringar förbehålles. - Använd endast belastning enligt anslutningstabellen på det dragna fordonet.
<b>CZ</b>	- Výslovně zdůrazňujeme, že jakákoli montáž, která není provedená ve specializované dílně, má za následek odvolání nároků na kompenzaci jakéhokoliv druhu, obzvláště vyplývajících ze zákona o odpovědnosti za způsobené škody.	- Změny mohou být provedeny bez oznámení. - Používejte pouze při maximálním nabití podle tabulky na tažném vozidle.
<b>DK</b>	- Vi ønsker at gøre udtrykkeligt opmærksom på at forkert samling, der ikke er udført af et specialiseret værksted, resulterer i bortfaldelse af kompenseringskrav af alle slags, i særdeles krav der måtte opstå omkring det lovpligtige ansvar.	- Kan ændres uden varsel. - Brug kun den maksimale belastning, i overensstemmelse med forbindelsestabellen for bugserede køretøjer.
<b>FI</b>	- Korostamme, että kaikki oikeudet vahinkokorvaukseen kuten myös valmistajan laillinen vastuu raukeavut, mikäli asennusta ei ole toteutettu oikealla tavalla eikä ammattitaitoisen asiantuntijan toimesta.	- Oikeus teknisiin muutoksiin ilman erillistä huomautusta pidätetään. - Kuormita työvirtapiiriä ainoastaan hinattavan ajoneuvon kytkentäkaavion mukaisesti.
<b>GR</b>	- Επισημαίνουμε κατηγορηματικά ότι οποιαδήποτε εσφαλμένη συναρμολόγηση, η οποία δεν έχει πραγματοποιηθεί ειδικό εργαστήριο θα οδηγήσει σε απονοίση των αξιώσεων επιβολής αποζημιώσεων οποιαδήποτε είδους, ειδικά όσα προκύπτουν από το νόμο ευθύνης προϊόντων.	- Μπορεί να τροποποιηθεί χωρίς προηγούμενη ειδοποίηση. - Χρησιμοποιείτε μόνο μέγιστο ηλεκτρικό φορτίο σύμφωνα με τον πίνακα σύνδεσης στο ρυμούλκούμενο όχημα.
<b>NO</b>	- Vi påpeker ettertrykkelig at all rett til skadeerstatning og rettslig ansvar forfaller dersom monteringen ikke er blitt utført på riktig måte og av et profesjonelt verksted.	- Tekniske endringer forbeholdes. - Overskrid ikke grensene anvist i tilkoblingstabellen på tilhengeren eller det tilkoblede kjøretøyet.
<b>PL</b>	- Chcielibyśmy wyraźnie zaznaczyć, iż wszelki nieprawidłowy montaż, który nie jest wykonywany w specjalistycznym warsztacie pociąga za sobą utratę możliwości dochodzenia wszelkiego typu roszczeń, w szczególności tych wynikających z odpowiedzialności producenta za swój produkt.	- Podlega zmianom bez powiadomienia. - Używać tylko takiego maksymalnego obciążenia które wynika z tabliczki połączeń holowanego pojazdu.

Einzelteilliste

Liste de pieces

Onderdelenlijst

Part list

Lista de componentes

Elenco componenti

Dellista

Seznam dílů

Del-liste

Osaluettelo

Κατάλογος εξαρτημάτων

Delliste

Lista części

(DE)

(FR)

(NL)

(GB)

(ES)

(IT)

(SE)

(CZ)

(DK)

(FI)

(GR)

(NO)

(PL)

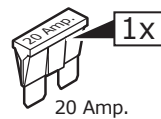
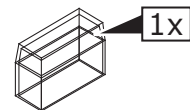
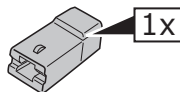
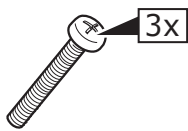
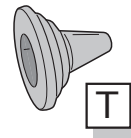
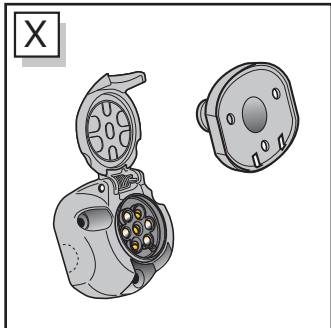
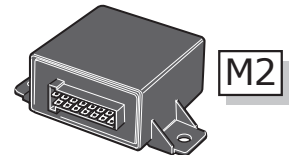
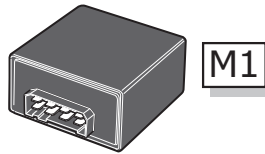
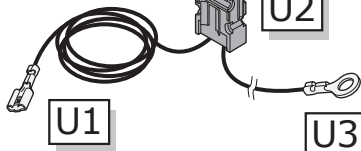
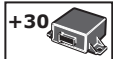
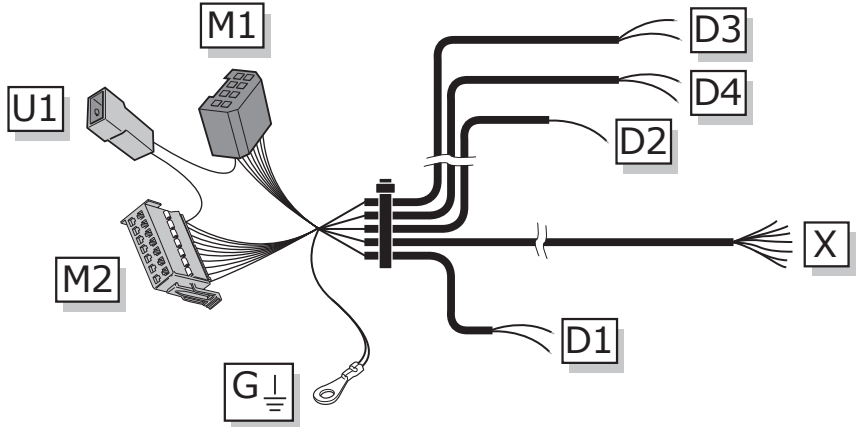
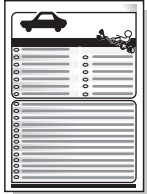
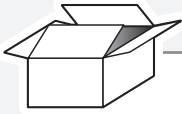

20 Amp.

**INFO**

	BK	BN	BU	GY	GN	WH	YE	OG	PE	PI	RD
DE	Schwarz	Braun	Blau	Grau	Grün	Weiß	Gelb	Orange	Violett	Rosa	Rot
FR	Noir	Marron	Bleu	Gris	Vert	Blanc	Jaune	Orange	Violet	Rose	Rouge
NL	Zwart	Bruin	Blauw	Grijs	Groen	Wit	Geel	Oranje	Paars	Roze	Rood
GB	Black	Brown	Blue	Grey	Green	White	Yellow	Orange	Purple	Pink	Red
ES	Negro	Marrón	Azul	Gris	Verde	Blanco	Amarillo	Naranja	Morado	Rosa	Rojo
IT	Nero	Marrone	Blu	Grigio	Verde	Bianco	Giallo	Arancione	Viola	Rosa	Rosso
SE	Svart	Brun	Blå	Grå	Grön	Vit	Gul	Orange	Lila	Rosa	Röd
CZ	Černá	Hnědá	Modrá	Šedá	Zelená	Bílá	Žlutá	Oranžová	Fialová	Růžová	Červená
DK	Sort	Brun	Blå	Grå	Grøn	Hvid	Gul	Orange	Lilla	Pink	Rød
FI	Musta	Ruskea	Sininen	Harmaa	Vihreä	Valkoinen	Keltainen	Oranssi	Purppura	Vaaleanpunainen	Punainen
GR	Μαύρο	Καφέ	Μπλε	Γκρι	Πράσινο	Λευκό	Κίτρινο	Πορτοκαλί	Μοβ	Ροζ	Κόκκινο
NO	Svart	Brun	Blå	Grå	Grønn	Hvit	Gul	Oransje	Lilla	Rosa	Rød
PL	Czarny	Brązowy	Niebieski	Szary	Zielony	Biały	Żółty	Pomarańczowy	Purpurowy	Różowy	Czerwony

**ROUTING**

**Sedan**

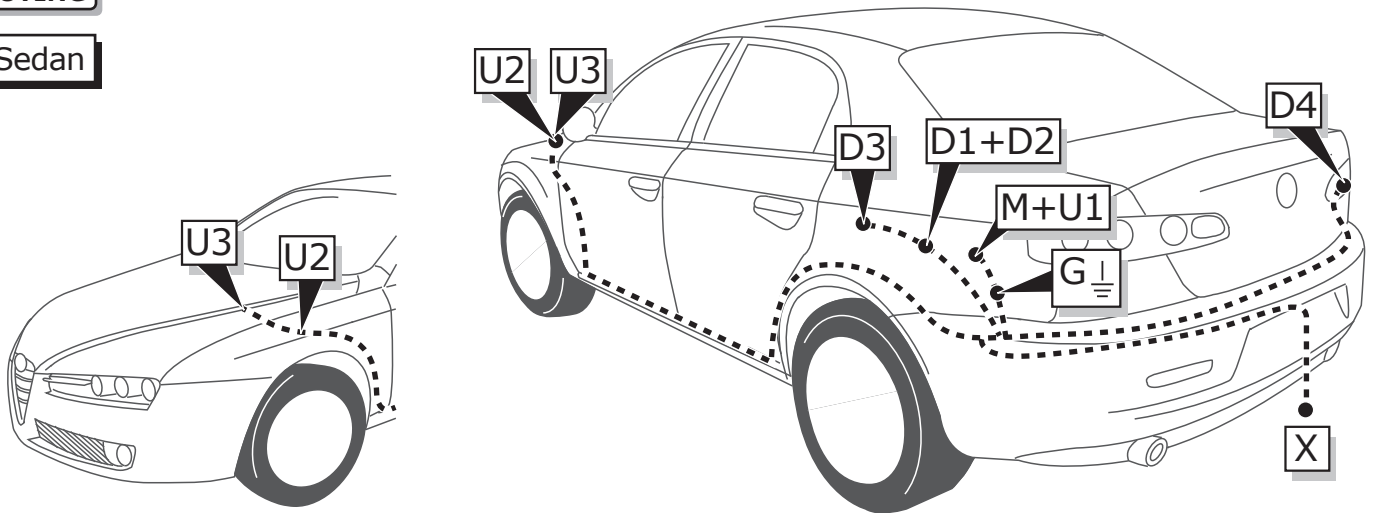

**Wagon**

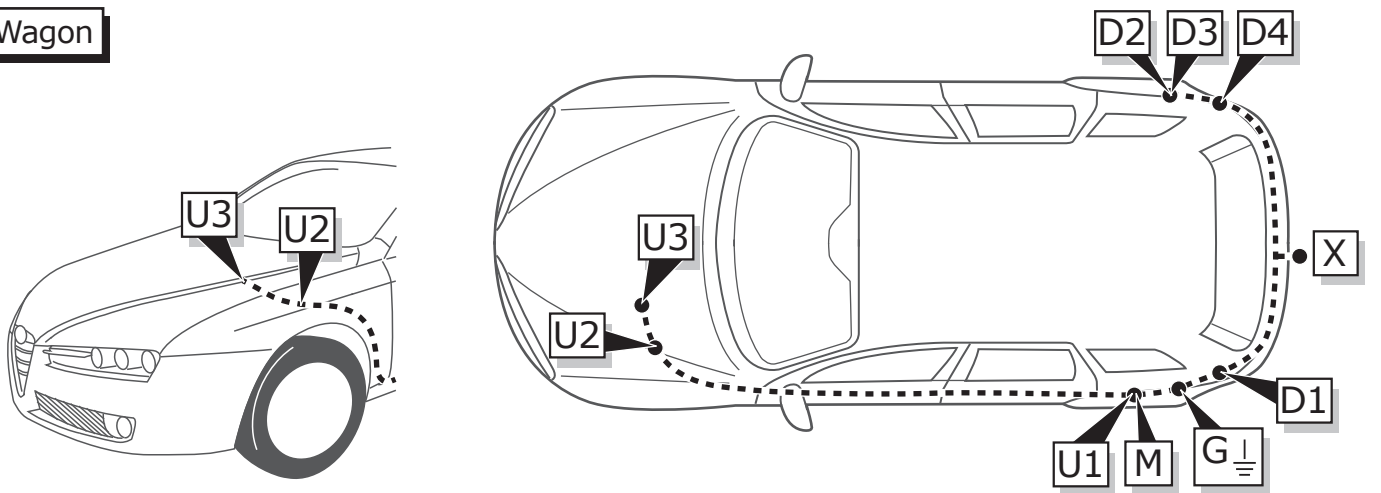

1

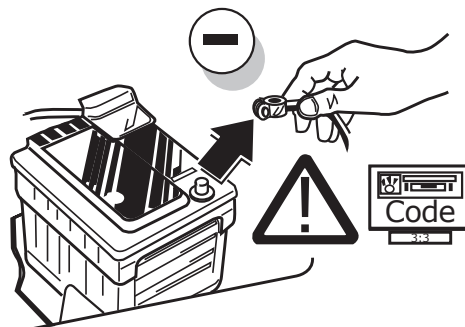

2

Sedan

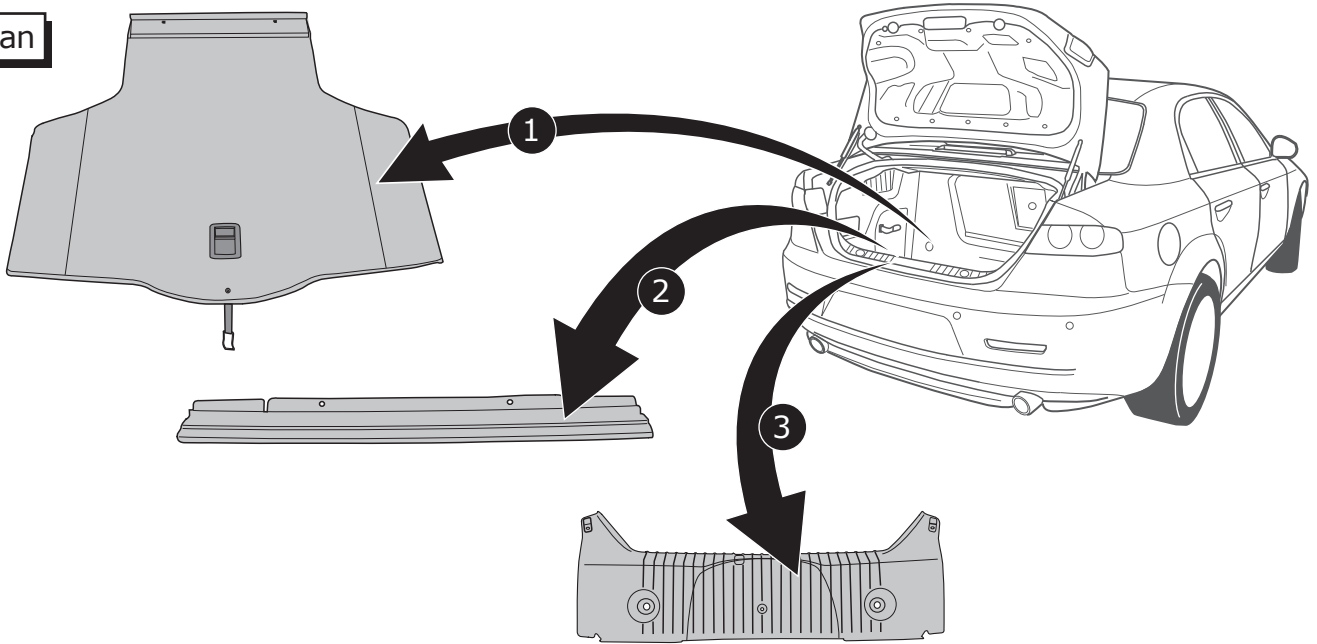

3

Sedan

1

2

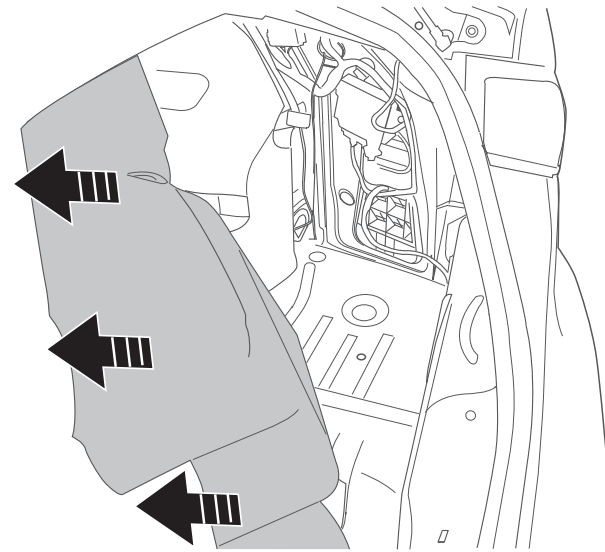
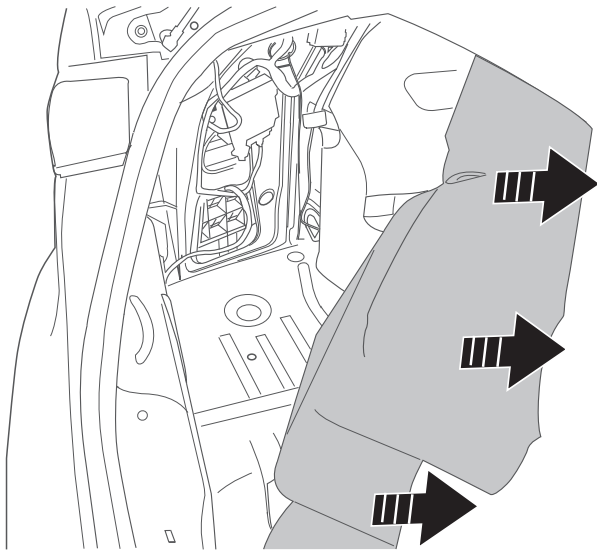

4

Sedan

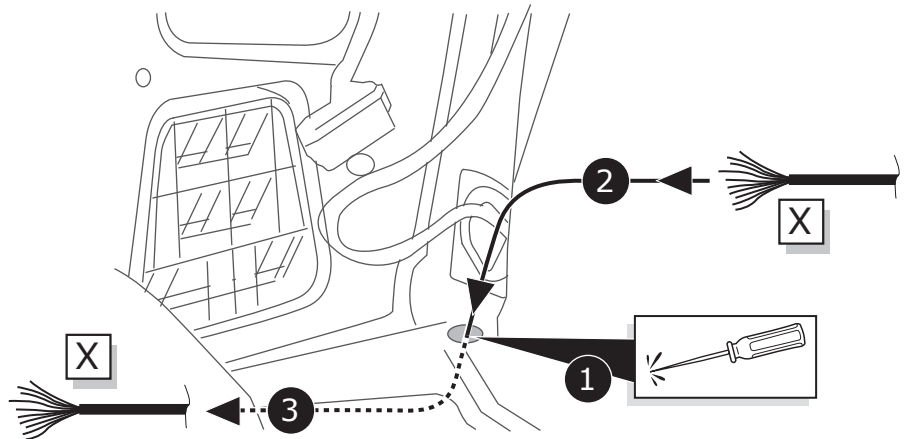
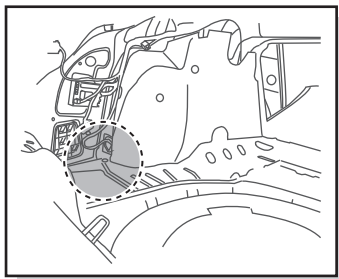

5

Wagon

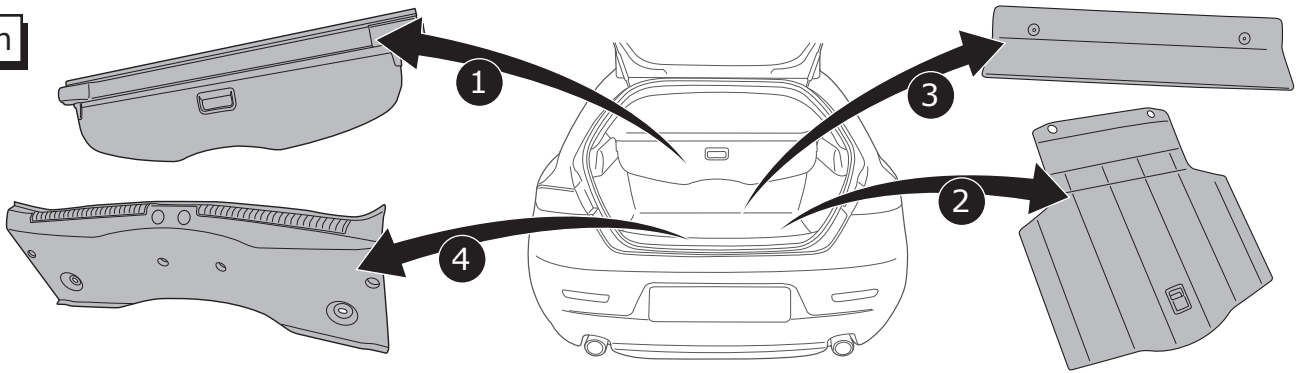

6

Wagon

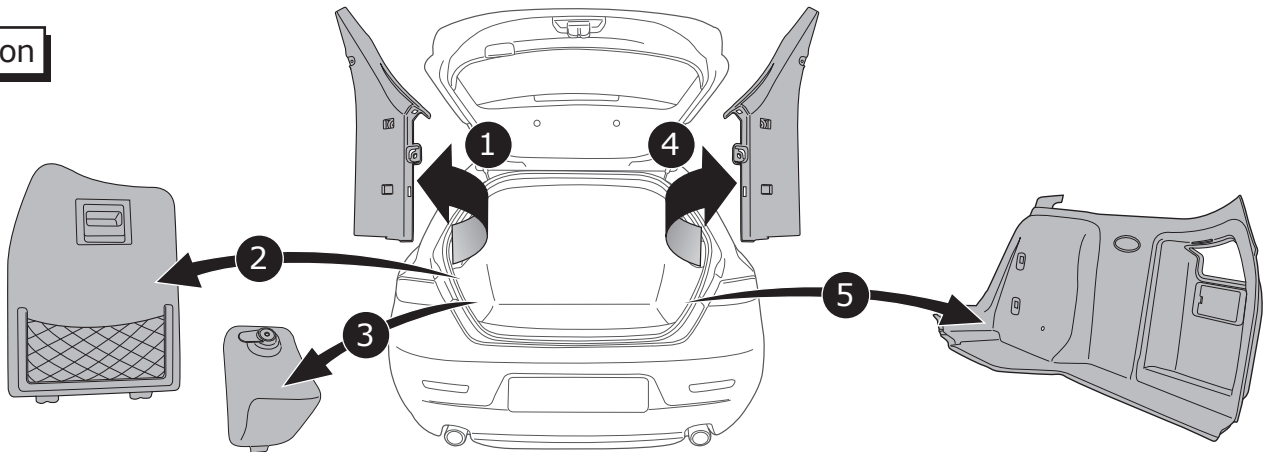

7

Wagon

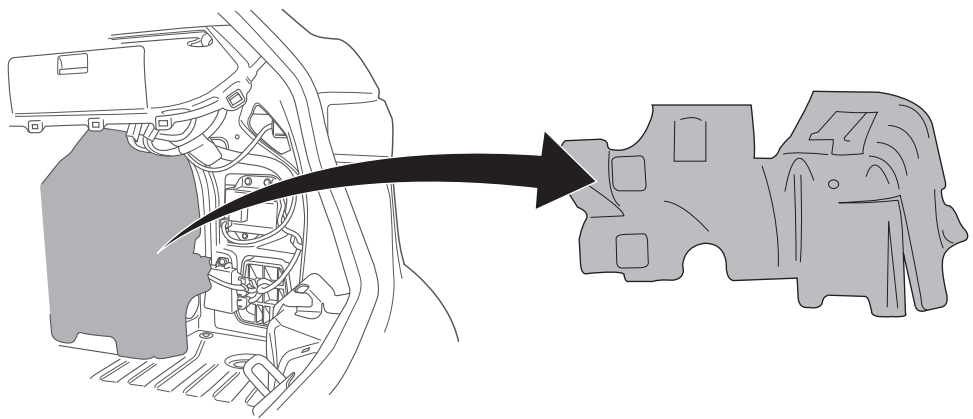
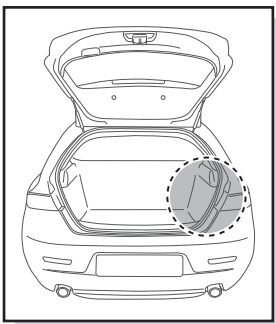

8

Wagon

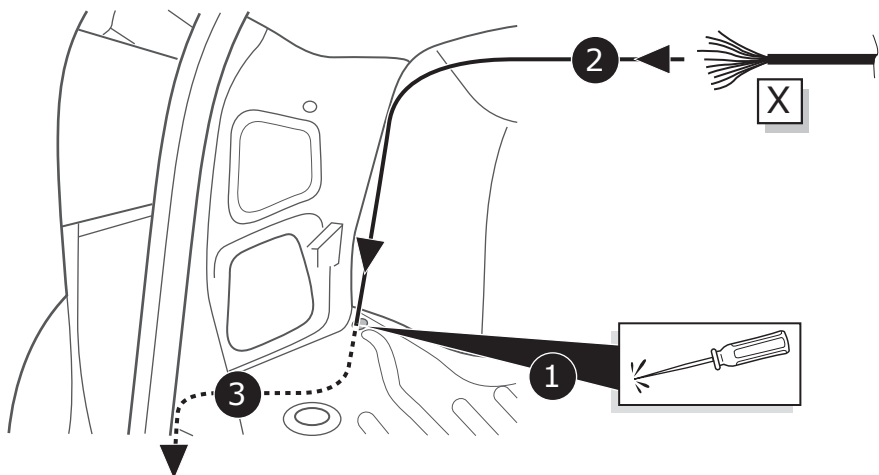
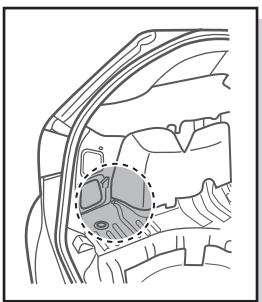

9

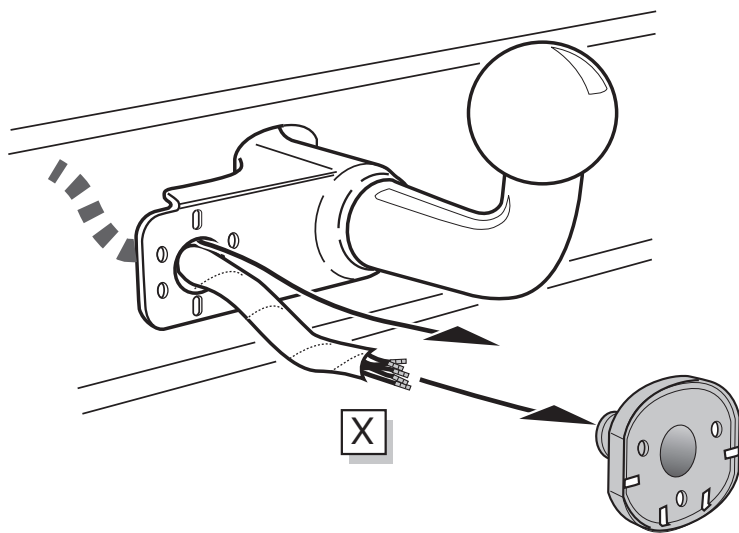

INFO

- (DE) Anschluss Steckdose
- (FR) Connection de la prise
- (NL) Contactdoos aansluiting
- (GB) Socket connection
- (ES) Conexión de la caja de enchufe
- (IT) Allaccio zoccolo
- (SE) Anslutning kontaktdosa
- (CZ) Objímkový konektor
- (DK) Stikdåse forbindelse
- (FI) Pistorasia liitäntä
- (GR) Υποδοχή σύνδεσης
- (NO) Tilkobling koblingsboks
- (PL) Połączenie przez gniazdo



Pag. 13

10

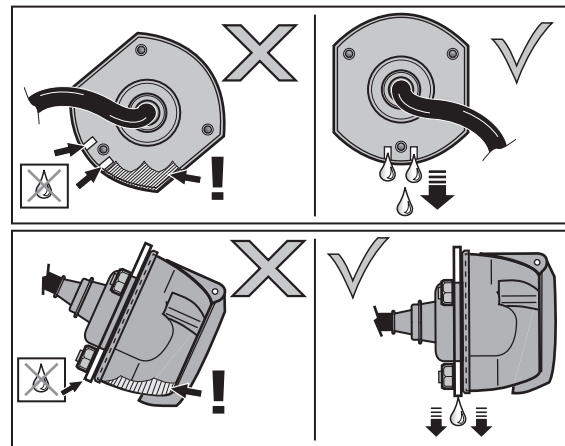
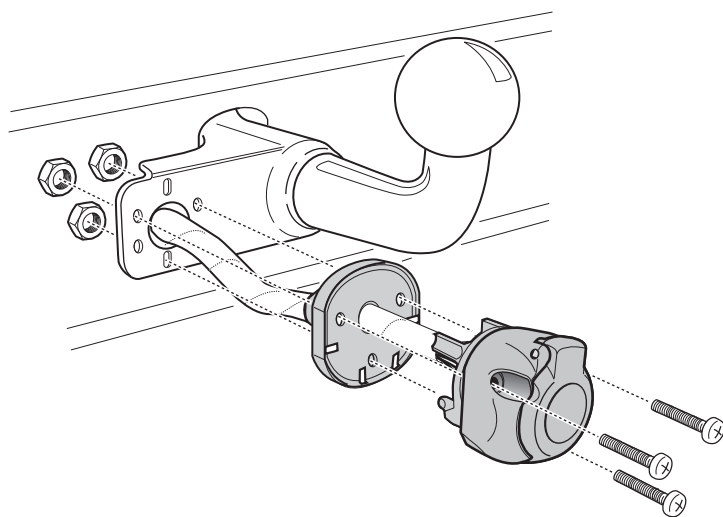

11

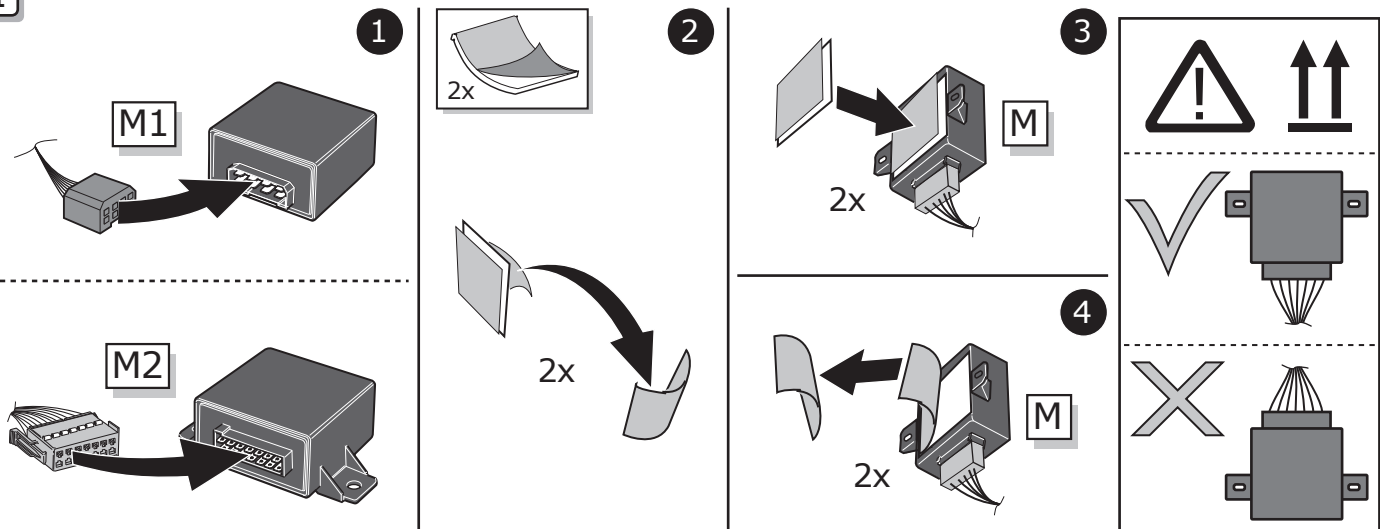



12

Sedan

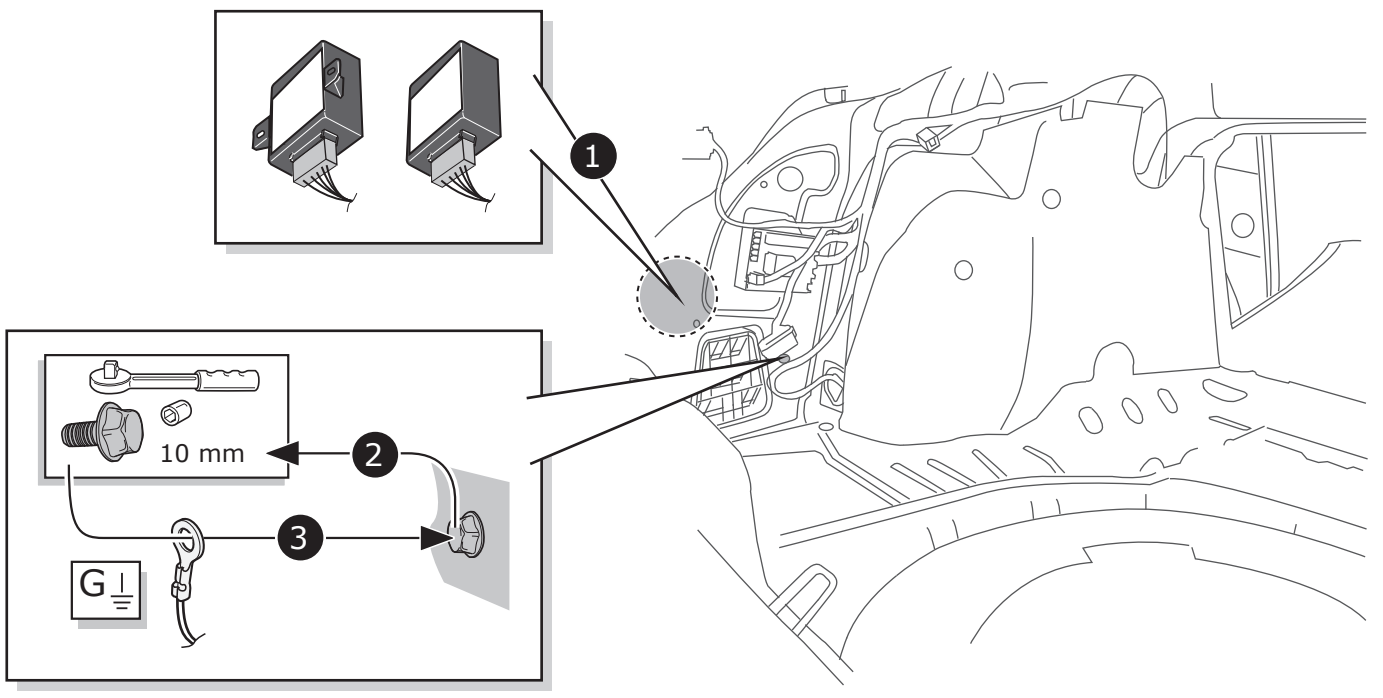





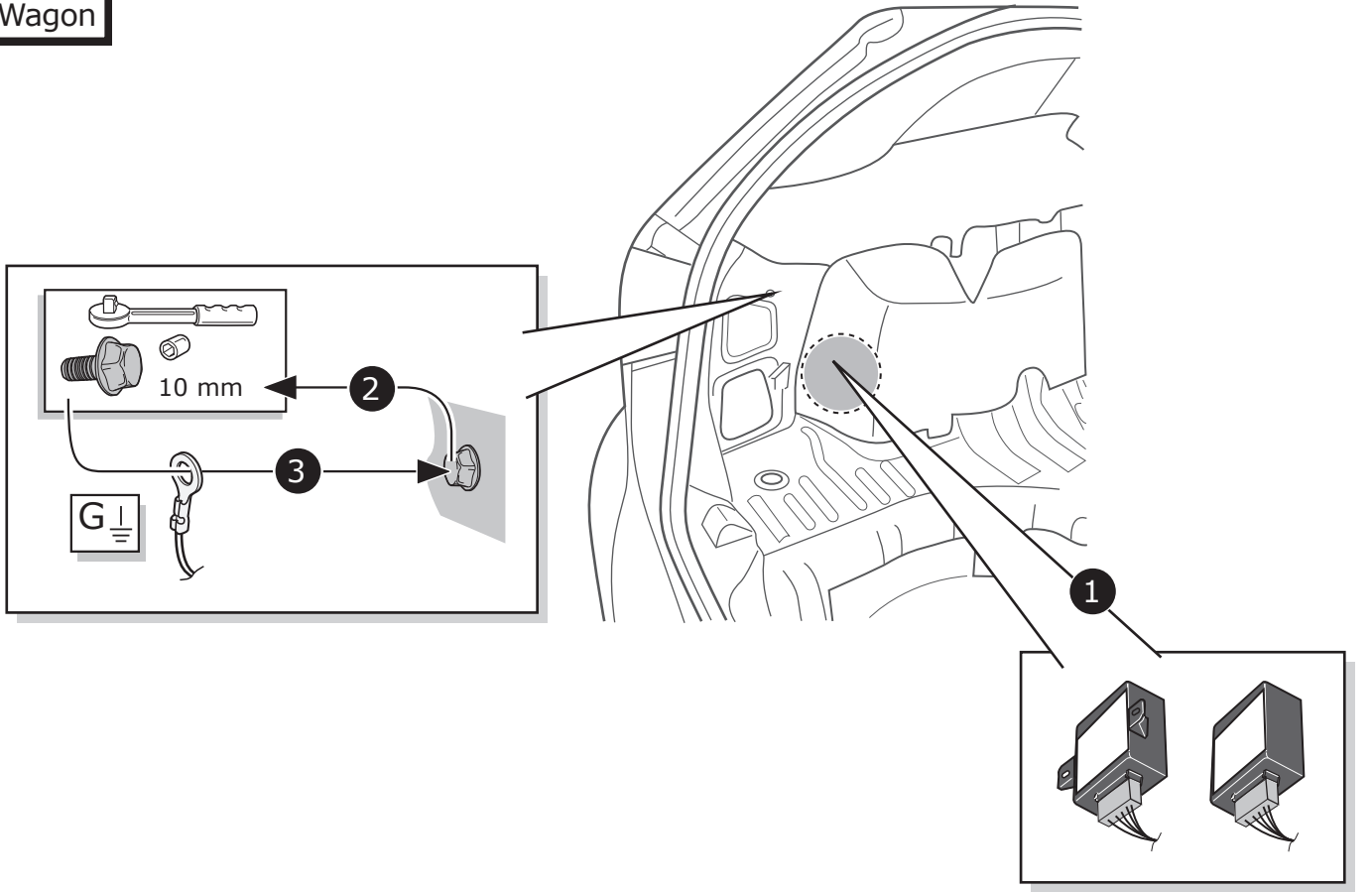



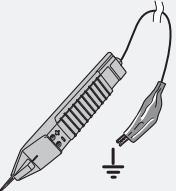



13

Wagon







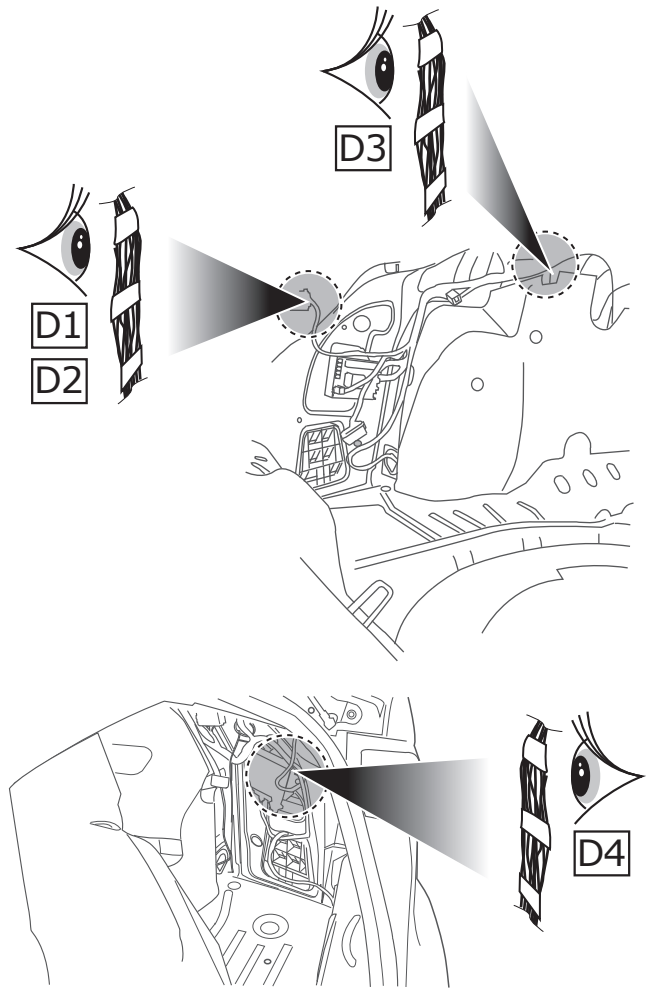



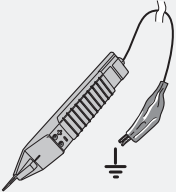



Sedan

	<ul style="list-style-type: none"> <li>DE Farben</li> <li>FR Couleurs</li> <li>NL Kleuren</li> <li>GB Colours</li> <li>ES Colores</li> <li>IT Colori</li> <li>SE Färgar</li> </ul>	<ul style="list-style-type: none"> <li>CZ Barevným</li> <li>DK Farverne</li> <li>FI Coloria</li> <li>GR χρώματα</li> <li>NO Farget</li> <li>PL Kolorować</li> </ul>	
D1	L ←	 .....	
D1	58L ☀	 .....	
D2	54 STOP	 .....	
D3	L+R ⚡	 .....	
D4	R →	 .....	
D4	58R ☀	 .....	



Wagon

	<ul style="list-style-type: none"> <li>DE Farben</li> <li>FR Couleurs</li> <li>NL Kleuren</li> <li>GB Colours</li> <li>ES Colores</li> <li>IT Colori</li> <li>SE Färgar</li> </ul>	<ul style="list-style-type: none"> <li>CZ Barevným</li> <li>DK Farverne</li> <li>FI Coloria</li> <li>GR χρώματα</li> <li>NO Farget</li> <li>PL Kolorować</li> </ul>	
D1	L ←	 .....	
D1	58L ☀	 .....	
D2	54 STOP	 .....	
D3	L+R ⚡	 .....	
D4	R →	 .....	
D4	58R ☀	 .....	

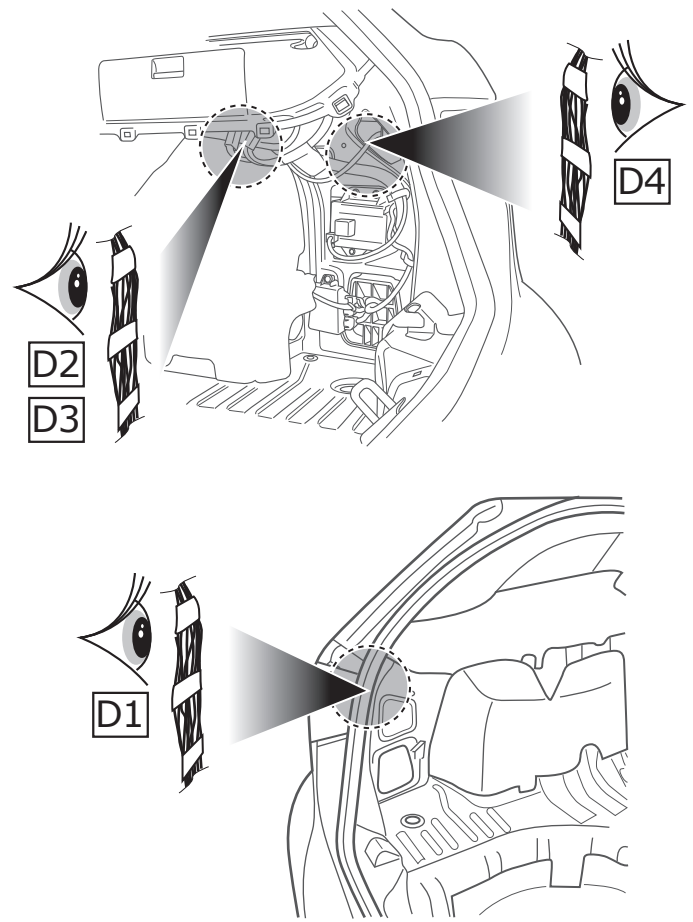



Sedan

	Farben Couleurs Kleuren Colours Colores Colori Färgar	Barevným Farverne Coloria χρώματα Färget Kolorować
D1	L ←	
D1	SBL ⚙	
D2	54 ⏸	
D3	L+R ⚙	
D4	R →	
D4	SBR ⚙	

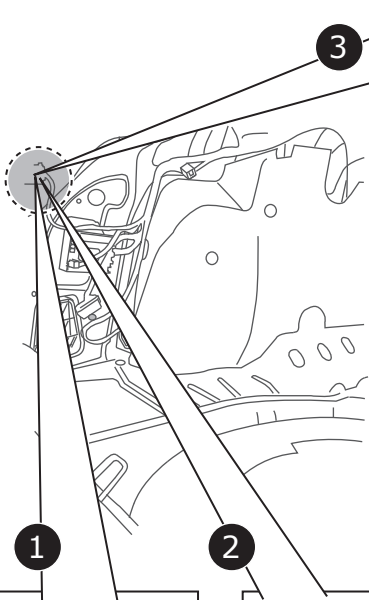

1

2

3

54 STOP

D2 BU/RD

1

L ←

BK/YE D1

2

3

1

58L ⚡

PE/BK D1

2

3

Sedan

	Farben Couleurs Kleuren Colours Colores Colori Färgar	Barevným Farverne Coloria χρώματα Färget Kolorować
D1	L ←	
D1	SBL ⚙	
D2	54 ⏸	
D3	L+R ⚙	
D4	R →	
D4	SBR ⚙	

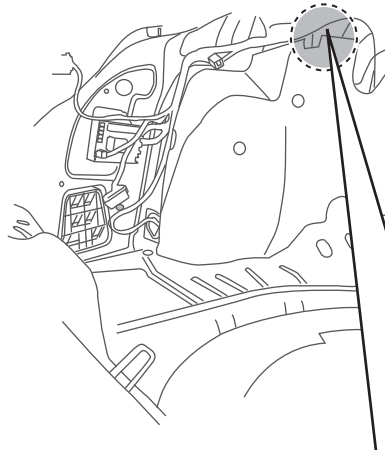

1

RD/YE

D3 GY

2

3

Sedan

	Farben	Barevným
	Couleurs	Farverne
	Kleuren	Coloria
	Colours	צבעים
	Colores	צבעות
	Colori	צבעות
	Färgar	Kolorować

D1	L ←	
D1	58L ⚙	
D2	54 ⚙	
D3	L+R ⚙	
D4	R →	
D4	58R ⚙	

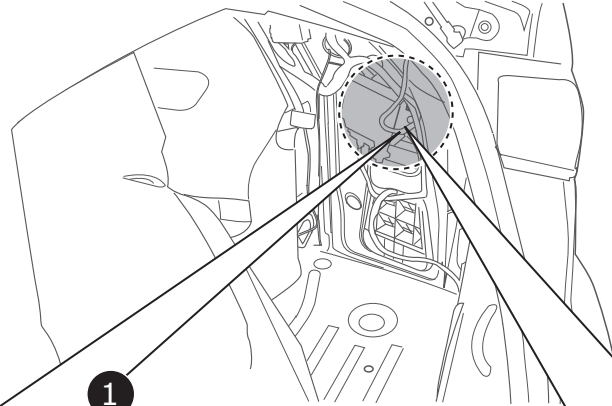

1 

2

3

1 

2

3

Wagon

	Farben	Barevným
	Couleurs	Farverne
	Kleuren	Coloria
	Colours	צבעים
	Colores	צבעות
	Colori	צבעות
	Färgar	Kolorować

D1	L ←	
D1	58L ⚙	
D2	54 ⚙	
D3	L+R ⚙	
D4	R →	
D4	58R ⚙	

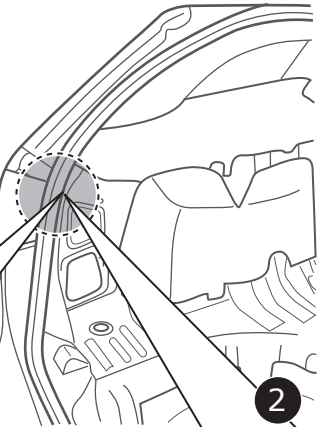

1 

2

3

1 

2

3

Wagon

	Farben Couleurs Kleuren Colours Colores Colori Färgar	Barevným Farverne Coloria Spoločnosť Farget Kolorovač
D1 L ←		
D1 SBL ⚙️		
D2 54 ⚙️		
D3 L+R ⚙️		
D4 R →		
D4 SBR ⚙️		

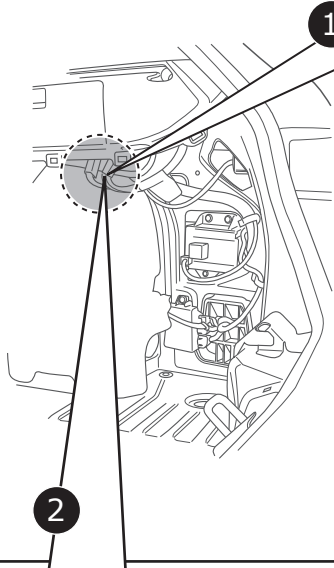

1

2

3

D2 BU/RD

1

RD/YE

D3

GY

2

3

D3

Wagon

	Farben Couleurs Kleuren Colours Colores Colori Färgar	Barevným Farverne Coloria Spoločnosť Farget Kolorovač
D1 L ←		
D1 SBL ⚙️		
D2 54 ⚙️		
D3 L+R ⚙️		
D4 R →		
D4 SBR ⚙️		

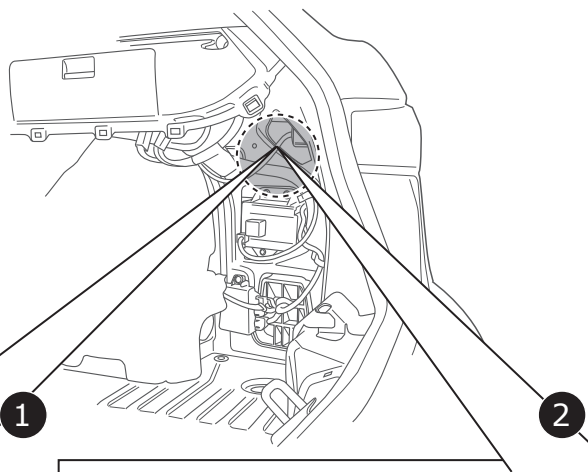

1

R →

BK/GN

D4

2

3

1

58R ⚙️

BK/BN

D4

2

3

21

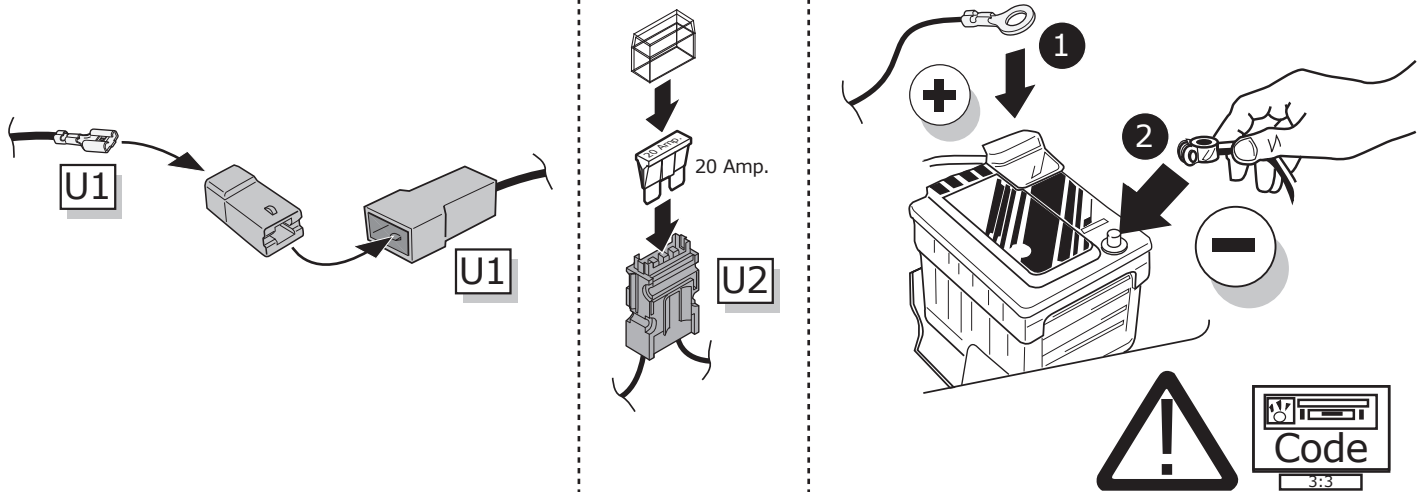

22

**DE** FUNKTIONEN KONTROLLIEREN MIT EINEM PRÜFGERÄT MIT WIDERSTAND ODER MIT LEUCHTEN MIT DER GENAUEN WATTAHLE!

**FR** CONTRÔLER LES FONCTIONS AVEC UNE BOÎTE DE TEST AVEC DE LA CHARGE OU DES LAMPES AVEC LA QUANTITÉ CORRECTE DE WATT!

**NL** CONTROLEER FUNCTIES MET EEN TESTER MET BELASTING OF LAMPEN MET DE JUISTE WATTAGE!

**GB** TEST ALL CIRCUIT FUNCTIONS WITH A TESTBOX WITH THE CORRECT POWER LOAD FOR EACH UNIT. A TESTBOX ON WHICH ONLY LEDs ARE USED CAN NOT BE USED IN THIS CASE

**ES** ¡CONTROLAR FUNCIONES CON UN TESTER CON CARGA O LUCES CON EL CORRECTO WATTAJE!

**IT** CONTROLLA FUNZIONI CON UN TESTER CON CARICO O LAMPADRE DEL GIUSTO WATT-TAGGIO!

**SE** KONTROLLERA FUNKTIONERNA MED EN TESTARE MED BELASTNING ELLER LAMPOR MED RÄTT WATT-VÄRDE!

**CZ** OVĚŘTE FUNKCE POMOČÍ TESTOVACÍHO BOXU NEBO SVĚTEL S PŘÍSLUŠNÝM VÝKONEM!

**DK** CHECK FUNKTIONERNE MED EN TESTBOKS, MED BELASTNING ELLER MED LYGTTER MED DET KORREKTE ANTAL WATT!

**FI** TARKISTA TOIMINNOT KÄYTTÄMÄLLÄ TESTILAITE, JOSSA ON OIKEATEHOINEN KUORMITUS TAI OIKEATEHOISET LAMPUT!

**GR** ΕΛΕΓΞΤΕ ΤΙΣ ΛΕΙΤΟΥΡΓΙΕΣ ΜΕ ΈΝΑ ΚΙΒΩΤΙΟ ΔΟΚΙΜΗΣ ΜΕ ΦΟΡΤΙΟ Ή ΛΑΜΠΙΤΗΡΕΣ ΣΩΣΤΗΣ ΠΟΣΟΤΗΤΑΣ ΒΑΤ!

**NO** KONTROLER FUNKSJONENE MED EN TESTER MED BELASTNING ELLER LYSPÆRER MED RIKTIG WATTVERDI!

**PL** SPRAWDŹ FUNKCJE UŻYWAJĄC SKRZYŃKI TESTOWEJ Z OBCIĄŻENIEM LUB PODŁĄCZONYMI ŻARÓWKAMI O ODPOWIEDNIEJ MOCY!

## INFO

**DE** Einzelteile wieder einbauen

**FR** Montez les part enlevées

**NL** Terug plaatsen onderdelen

**GB** Reinstall linings

**ES** Reinstalar componentes

**IT** Rimetti a posto componenti

**SE** Sätt tillbaka delar

**CZ** Znovu zasuňte obložení

**DK** Påsæt beklædningen

**FI** Asenna verhoilut takaisin

**GR** Τοποθεήστε ξανά τις επενδύσεις

**NO** Sett tilbake deler

**PL** Założyć wykładzinę

23

- DE** Gebrauchsanleitung.
- FR** Mode d'emploi.
- NL** Gebruikershandleiding.
- GB** User guide.
- ES** Guía del usuario.
- IT** Manuale di istruzioni.
- SE** Bruksanvisning.
- CZ** Uživatelská příručka.
- DK** Brugervejledning.
- FI** Käyttöohjeet.
- GR** Οδηγός χρήστη.
- NO** Brukerveiledning.
- PL** Instrukcja obsługi.

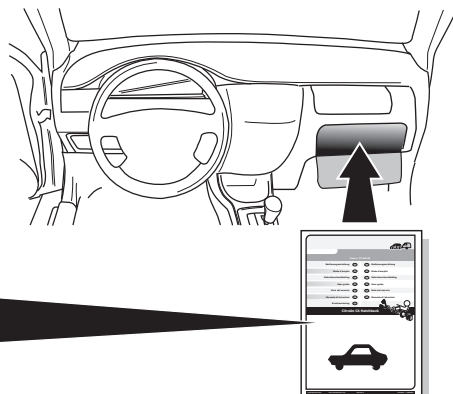







**00800**  
**CALL2ECS**  
**22 55 23 27**

09.00 - 18.00  
Monday - Friday  
[www.ecs-electronics.nl](http://www.ecs-electronics.nl)

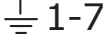
**INFO**

- |                                     |                               |
|-------------------------------------|-------------------------------|
| (DE) Anschluss Steckdose            | (CZ) Objímkový konektor       |
| (FR) Connection de la prise         | (DK) Stikdåse forbindelse     |
| (NL) Contactdoos aansluiting        | (FI) Pistorasia liitäntä      |
| (GB) Socket connection              | (GR) Υποδοχή σύνδεσης         |
| (ES) Conexión de la caja de enchufe | (NO) Tilkobling koblingsboks  |
| (IT) Allaccio zoccolo               | (PL) Połączenie przez gniazdo |
| (SE) Anslutning kontaktdosa         |                               |

DIN/ISO 1724							
	1/L	2	3/31	4/R	5/58-R	6/54	7/58-L
Pmax	21W	2x21W		21W	52W	3x21W	52W
(DE)	Gelb	Blau	Weiß	Grün	Braun	Rot	Schwarz
(FR)	Jaune	Bleu	Blanc	Vert	Marron	Rouge	Noir
(NL)	Geel	Blauw	Wit	Groen	Bruin	Rood	Zwart
(GB)	Yellow	Blue	White	Green	Brown	Red	Black
(ES)	Amarillo	Azul	Blanco	Verde	Marrón	Rojo	Negro
(IT)	Giallo	Blu	Bianco	Verde	Marrone	Rosso	Nero
(SE)	Gul	Blå	Vit	Grön	Brun	Röd	Svart
(CZ)	Žlutá	Modrá	Bílá	Zelená	Hnědá	Červená	Černá
(DK)	Gul	Blå	Hvid	Grøn	Brun	Rød	Sort
(FI)	Keltainen	Sininen	Valkoinen	Vihreä	Ruskea	Punainen	Musta
(GR)	Κίτρινο	Μπλε	Λευκό	Πράσινο	Καφέ	Κόκκινο	Μαύρο
(NO)	Gul	Blå	Hvit	Grønn	Brun	Rød	Svart
(PL)	Żółty	Niebieski	Biały	Zielony	Brązowy	Czerwony	Czarny